

SECTIONAL WARP BEAM FOR DIRECT WARPING FROM SPOOLS OR SMALL BOBBINS

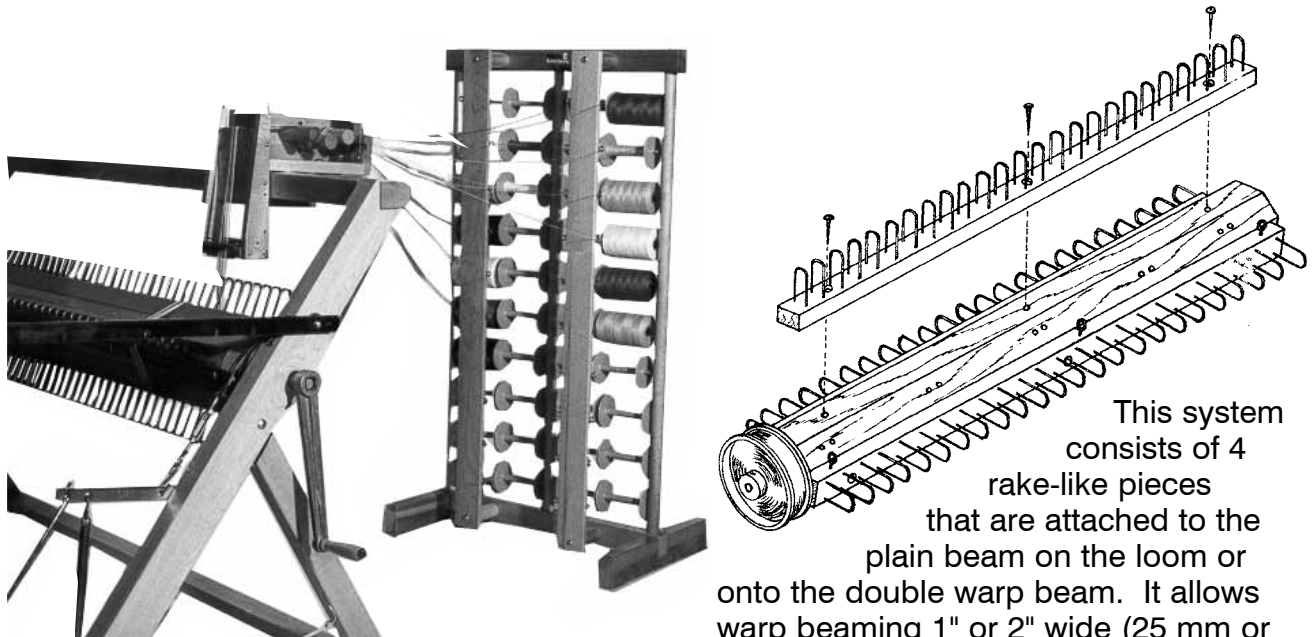

This system consists of 4 rake-like pieces that are attached to the plain beam on the loom or onto the double warp beam. It allows warp beaming 1" or 2" wide (25 mm or 50 mm) at a time and requires a number of spools according to the sett of warp ends.

On the Dorothy and the voyageur, the clamps are fixed directly on the beam; it holds 5" (12,5 cm) by turn. The Compact holds 15" (38 cm) per turn while on an Artisat or Inca, it holds 16" (40 cm) per rotation. On a Fanny, Mira, Nilus, Nilus II, Colonial I, Kebec or Nilart, it holds 19" (48 cm) per rotation. A sectional warp beam is especially appreciated by the weaver without a helper since the warp can be beamed easily by one person.

1" (25mm) sections		
6443-1100	24" Dorothy	\$262.00
6443-2000	22"	\$192.50
6443-3000	24"	\$246.00
6441-3000	27"	\$246.00
6443-4000	32"	\$246.00
6441-4000	36"	\$246.00
6441-5000	45"	\$294.00
6441-6000	60"	\$375.00
6441-6720	72"	\$417.00
6441-7000	100"	\$546.00
6441-8000	120"	\$744.00

2" (50mm) sections		
6442-4000	36"	\$214.00
6442-5000	45"	\$241.00
6442-6000	60"	\$316.00
6442-7000	100"	\$439.00
6442-8000	120"	\$546.00

EXTENSION KIT TO CONVERT SECTIONAL WARP BEAM TO 1 YARD PER TURN (91 CM)



Note:
not for the Compact and Artisat looms

6161-2000	For loom from 27" to 36" (70 - 90 cm) 12 pieces	\$48.00
6161-6000	For 45" (115 cm) loom 16 pieces	\$70.00
6161-7000	For 60" (150 cm) loom 16 pieces + 12 blocks	\$102.00
6162-4000	For 100" (250 cm) loom 24 pieces + 20 blocks	\$134.00
6162-5000	For 120" (300 cm) loom 32 pieces + 28 blocks	\$155.00



SECTIONAL WARPING

TENSION BOX

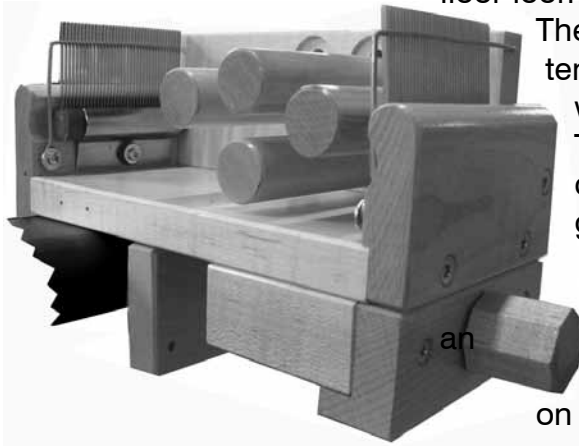

The tension box is used with the Sectional Warp Beam and is adjustable to fit any Leclerc floor loom.

The tension is adjustable for uniform tension on all warp ends as they are wound from the spool rack to the loom. Two open 12 threads per inch (4.8 / cm) combs allow easy threading and help guide threads into the proper section.

The tension box can also be used with optional counter when filling bobbins, to give the number of meters or yards on bobbins.

6160-1000

\$155.00

COUNTER

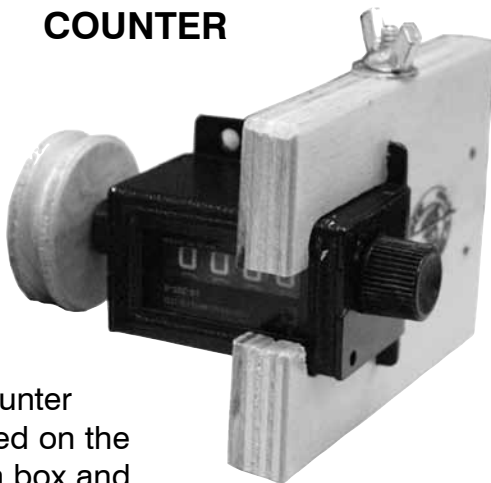

The counter is placed on the tension box and measures the yardage of the warp to ensure that all sections are of the same length.

Easily removable from the tension box.

6160-6000 (english system) \$110.00

6160-8000 (metric system) \$110.00

TENSION BOX EXTENSION

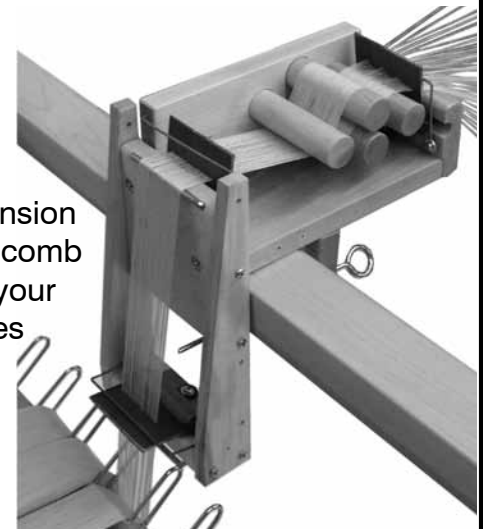

This extension with one comb close to your warp gives you better control on the width

of the yarn section (1" or 2") so the guides are not needed. Height of comb is adjustable. Good for sectional warp beam with or without extension.

1042-0000 \$62.00



SECTIONAL WARPING

DIVIDERS



Useful when beaming long warps. They are placed in each section every 5 or 10 yards (meters) to prevent uneven build-up of threads and keep uniform tension in the warp. They all have to be placed in the same turn

6165-1000 1" (25mm) sections \$22.50 / 100

6165-2000 2" (50mm) sections \$30.00 / 100

GUIDES

A set of 8 pieces that fit the steel divisions for each section of the sectional warp beam. They prevent the warp ends from going into other sections, or from staying on top of the divisions. When the section is filled, transfer to the next section.

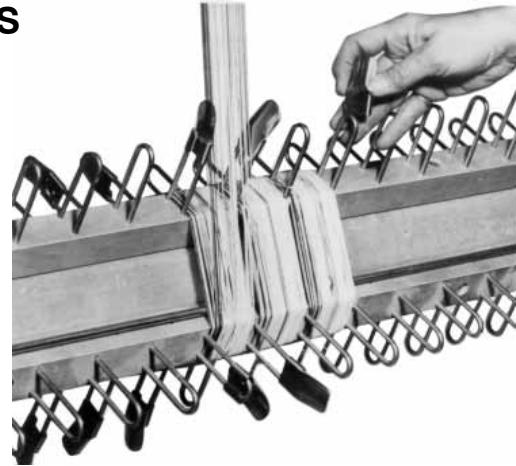

6166-1000 \$17.25 per set of 8

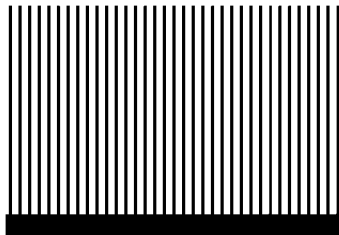

COMB FOR TENSION BOX

Any reed size available.
Indicate number of dents per inch (cm).

6260-0000 \$6.75

DOUBLING STAND

Doubling stand used for twisting two or three threads together.

One tube of yarn is placed on the floor, one on the lower shelf and one on the center shelf.

Thread passes through the center of the middle and upper cones (or tubes).

Thread from upper shelf then joins the two lower ones and passes through the hole in the top shelf.

Hang on wall (2 screws included) 2½" x 5½" x 25"
(Made of maple)



6360-1000 \$67.50

