

RADDLE

Fits in the beater (2 dents per inch)
Used to spread the warp when
beaming. It has an open top which
can be covered with top of beater.

6258-1000	Voyageur, Dorothy 15.75" (40 cm)	\$27.00
6258-2000	Meco 22" (56 cm)	\$31.00
6258-9001	Compact 24"	\$45.00
6258-9002	Voyageur, Dorothy 24" (60 cm)	\$45.00
6258-4000	36"	\$50.00
6258-5000	45"	\$60.00
6258-6000	60"	\$75.00



PADDLE

Used for warping
with more than
four ends (up to
twenty threads).
You make the
cross by sliding the
yarn up or down in
the slot.

6148-1000 \$21.00

5" Thread Clipper

Lightweight and very sharp!
Right or left handed!

Can be used on the loom
or for finishing
woven fabric.

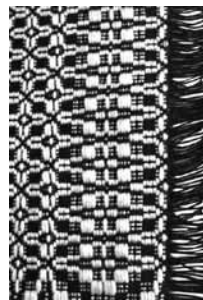

**6148-1001
\$14.00**

DROP SPINDLE



A beautifully balanced spindle,
in naturally finished hard wood.

Whorl : 3½" dia. (9,5 cm)

Shaft: 14" long (35,5 cm)

6170-2000 \$38.00



SHAFT STABILIZER



Used on counter-balanced and counter-march looms to keep shafts at same level and distance while threading.

6147-3000

\$16.00

THREADING HELPER

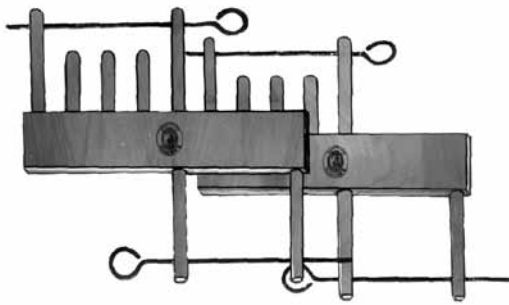

Used as a harness stabilizer and a support for the lease sticks and raddle. It holds the cross at a convenient height during the threading. May be used in a variety of configurations as shown below.

6147-4000 \$37.00 (2 pieces)

